

THIS DRAWING IS UNPUBLISHED. RELEASED FOR PUBLICATION
 © COPYRIGHT - By - ALL RIGHTS RESERVED.

LOC	DIST	REVISIONS 変更					
J	-	P	LTR	DESCRIPTION	DATE	DWN	APVD
			E2	REVISED PER ECO-11-005140	28MAR11	RK	HMR

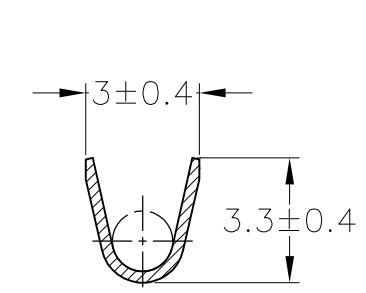

断面 A-A
SECT A-A

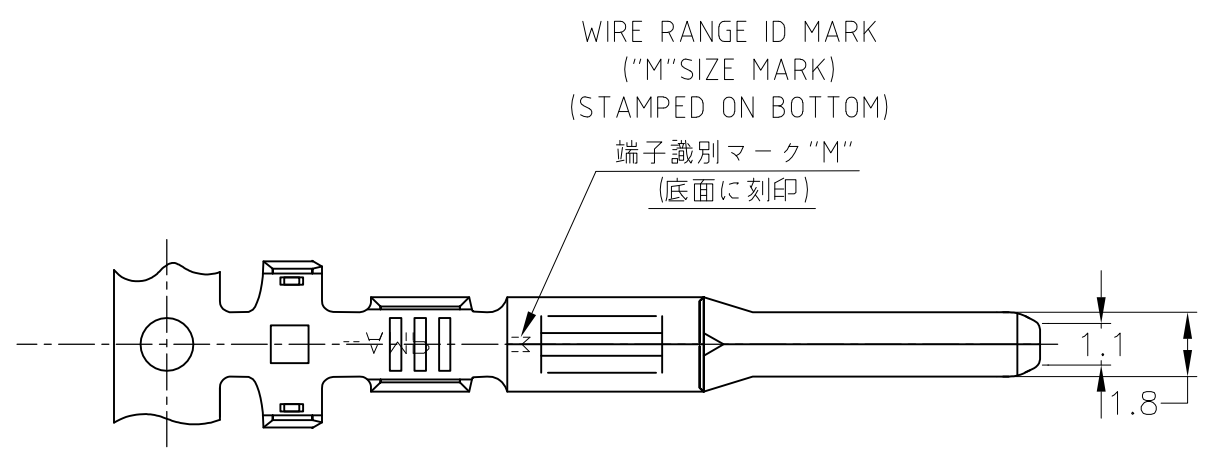
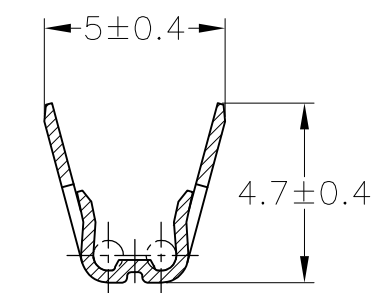

断面 B-B
SECT B-B

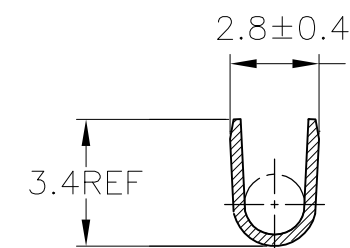
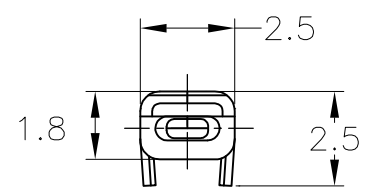
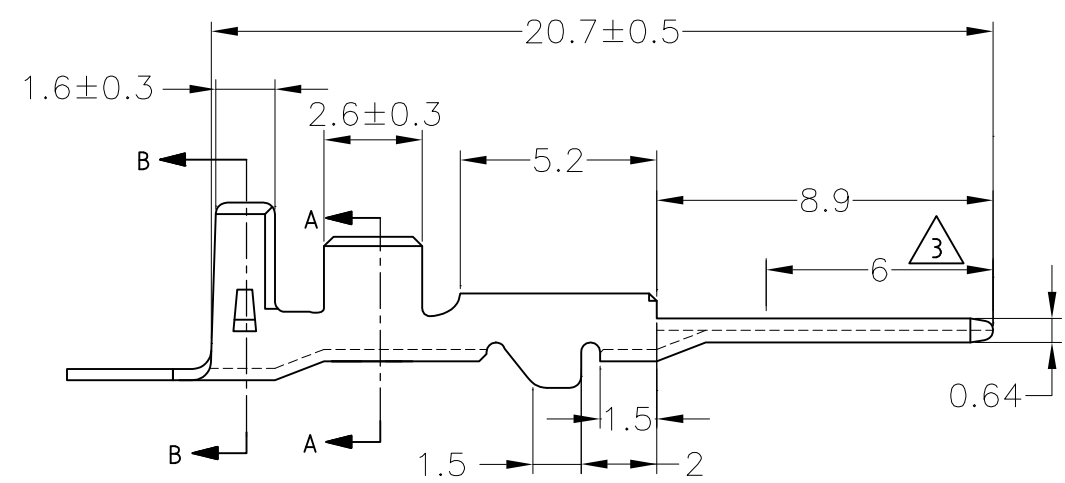

断面 A-A
SECT A-A
(175030のみ適用)
(ONLY 175030)

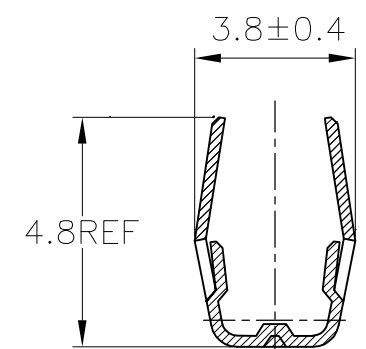

断面 B-B
SECT B-B
(175030のみ適用)
(ONLY 175030)

- 1. 製品規格 ; 108-5231, 108-5264
 - 2. 嵌合相手端子型番 ; 173631 他
 - 3. 圧着規格 ; 114-5092
-
- 1. SPEC; 108-5231, 108-5264
 - 2. RECEPTACLE CONTACT; 173631 etc
 - 3. APPLICATION SPECIFICATION; 114-5092

SEE DRAWING 173645-5			173645-5
175030-3	部分金めっき SELECTIVE GOLD	リン青銅 板厚0.32 PHOS BRO. ±0.32	173645-3
175030-2	錫めっき済み PRE-TINNED	リン青銅 板厚0.32 PHOS BRO. ±0.32	173645-2
175030-1	錫めっき済み PRE-TINNED	黄銅 板厚0.32 BRASS ±0.32	173645-1
パラ端子型番 L/P NUMBER	仕上 FINISH	材料 MATERIAL	型番 PART NUMBER

TOLERANCES UNLESS OTHERWISE SPECIFIED:
一般公差

10 ≥	±0.2
30 ≥ > 10	±0.25
100 ≥ > 30	±0.3
ANGLE	±3°

THIS DRAWING IS A CONTROLLED DOCUMENT.

DIMENSIONS: 単位: 耗 mm	TOLERANCES UNLESS OTHERWISE SPECIFIED: 一般公差
	0 PLC ±-
	1 PLC ±-
	2 PLC ±-
	3 PLC ±-
	4 PLC ±-
	ANGLES ±-
MATERIAL 材料	FINISH 仕上
SEE TABLE	SEE TABLE

DWN M.SUGAWARA 16MAY06	TE Connectivity 070 SERIES TAB CONTACT				
CHK T.SHINOHARA 16MAY06					
APVD K.BETSUI 16MAY06					
PRODUCT SPEC 製品規格 SEE NOTE	NAME 名称	SIZE	CAGE CODE	DRAWING NO 番号	RESTRICTED TO
APPLICATION SPEC 取付適用規格 SEE NOTE		A3	00779	G-173645	-
WEIGHT -	CUSTOMER DRAWING			SCALE 尺度 5:1	SHEET 1 OF 1
				REV E2	